

# 磁気近接用マグ

RoHS2対応

## AG001KH



■外形図

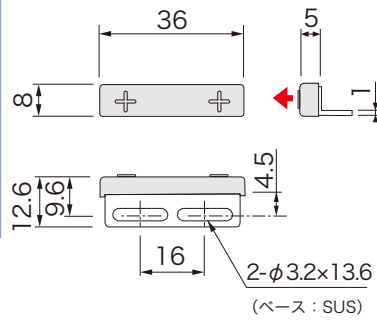

■磁気特性

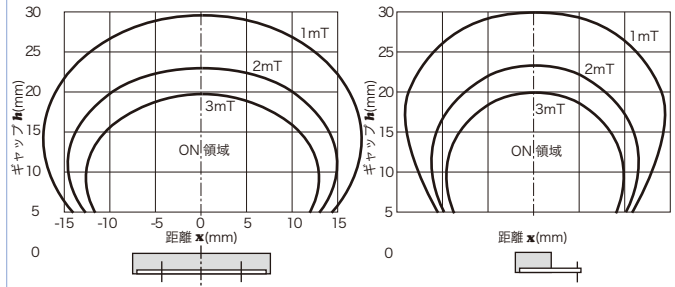

## AG002KH



■外形図

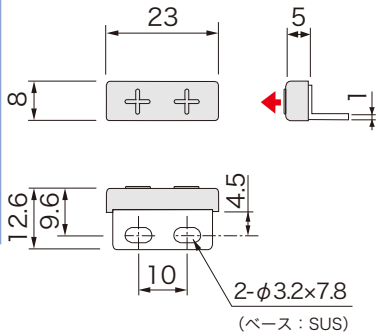

■磁気特性

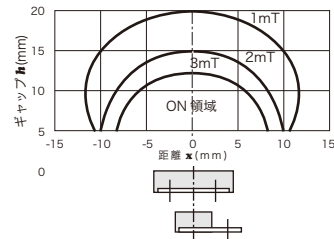

## AG003KH



■外形図

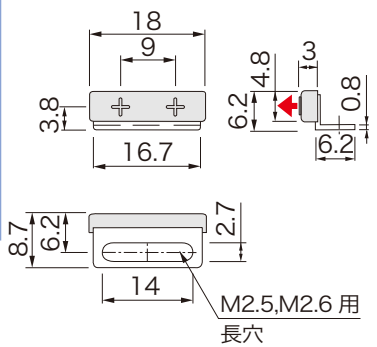

■磁気特性

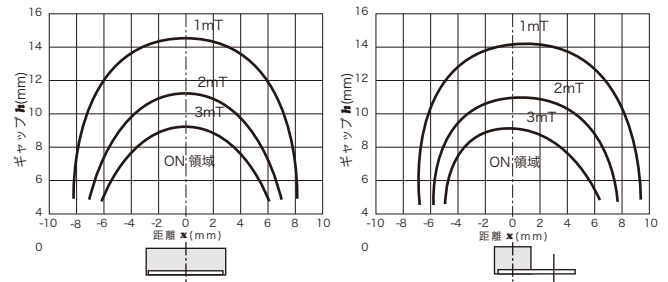

## AG004KH

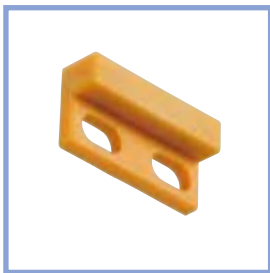

■外形図

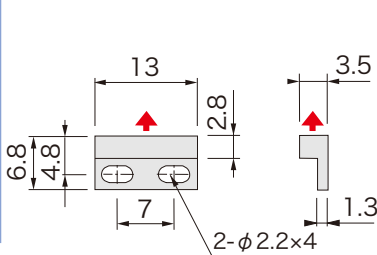

■磁気特性 ※M2 締付トルク 0.1N・m

